

4 Hood & Filter Placement and Start Up

- A.** For internal filters, install filter so it lines up beneath the hood cutout inside the tank. For external filters, align the filter so that it fits through the hood cutout on the outside of the tank.
- B.** Plug AC adapter into power outlet. Make a Drip Loop for safety.
- C.** Use Light Switch to power LEDs On & OFF.

Light Switch **C**

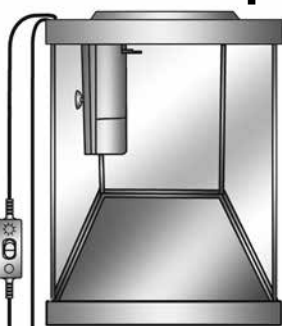

Install Filter **A**

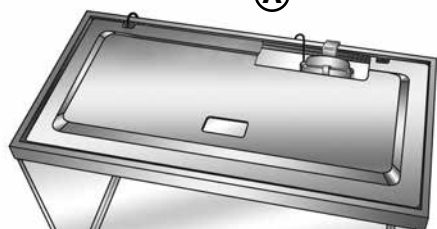

IMPORTANT:
Always unplug the LED Lights before inspecting or beginning any maintenance procedures.



B Drip Loop (for safety)

Troubleshooting Guidelines

If the LED hood does not fit snugly in the aquarium frame: If your hood comes with frame clips, make sure they are installed on the aquarium frame properly.

If the LED lights won't turn on: Make sure that the AC Adapter is plugged into an electrical source. Check to make sure the On/Off Switch is set to the 'On' position.

If the LED lights fall into the water: Unplug the low voltage AC Adapter plug/power cord. Allow the LED lights to dry out fully before turning 'On' again.

If the LED Light Modules won't slide into place: Make sure the Modules are positioned properly in the track. Realign the strand of LEDs with the tracks in which they belong before sliding into place, then follow the Quick Setup Guide instructions.

LIMITED ONE YEAR WARRANTY: Spectrum Brands, Inc. warrants this LED Hood against defects in material or workmanship for one year from the date of original purchase, subject to the conditions and exceptions stated below. Your sales receipt is your Proof-of-Date-of-Purchase. If the LED Hood exhibits such a defect, Spectrum Brands, Inc. will repair or replace it, at Spectrum Brands, Inc.'s option, without cost for parts or labor. The LED Hood must be shipped postage paid to Spectrum Brands, Inc. Proof-of-Date-of-Purchase is required. You are responsible for proper shipping. Call Customer Service at 800-526-0650 for return authorization and shipping address. This warranty does not cover damage caused by accident, misuse, abuse or failure to follow the instructions accompanying LED Hood. All implied warranties, including any implied warranty of merchantability or fitness for any purpose are limited to one year. Fish and plant loss, personal injury, property loss or damage (direct, incidental, or consequential) resulting from the use of the LED Hood are not covered by this warranty. Because some states/provinces do not allow the exclusion or limitation of incidental or consequential damages, or allow limitations on how long an implied warranty lasts, the above limitations or exclusion may not apply to you. This warranty gives you specific legal rights. You may also have other rights which vary from state/province to state/province.

Distributed by United Pet Group, a Division of Spectrum Brands, Inc.
3001 Commerce Street
Blacksburg, VA 24060

1-800-526-0650 • www.tetra-fish.com

GLOFISH and EXPERIENCE THE GLO are ® Registered Trademarks and READY, SET GLO! is a ™ Trademark of Yorktown Technologies, L.P. and are used under license.

©2015 Yorktown Technologies, L.P.

P/N R08433 Rev. A

Start Here - GloFish® Aquarium Kits

Quick Setup Guide for Kit Sizes: 5 and 10 gallons

1

Parts Check

NOTE: Number of Light Modules varies by hood size.

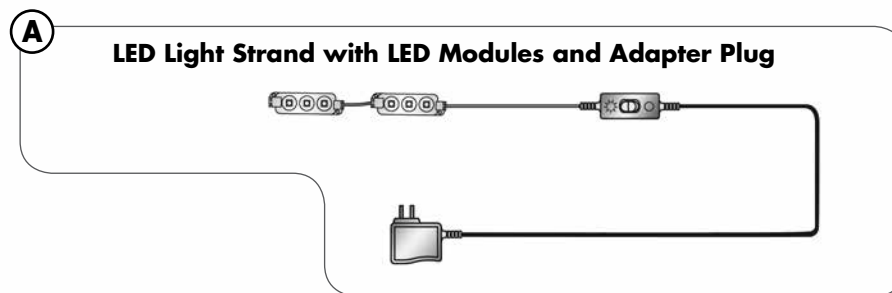

A LED Light Strand with LED Modules and Adapter Plug

LED Light Hood **B**

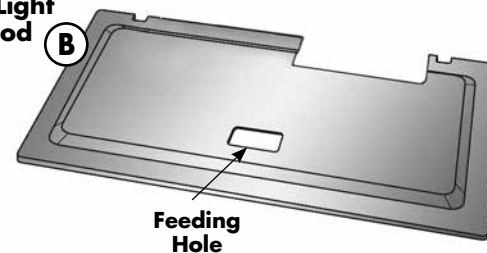

Feeding Hole



C Frame Clips
(For applicable models)

Replacement Parts List

KEY	ITEM #	DESCRIPTION
A	R07012	LED Light Strand — 1 Blue and 1 White Module with Adapter
A	R07013	LED Light Strand — 2 Blue and 2 White Modules with Adapter
B	R04826-01	Light Hood (16" x 8") for 2 LED Modules - use without Frame Clips
B	R07018-01	Light Hood (20" x 10") for 4 LED Modules - use without Frame Clips
B	R07018	Light Hood (20" x 10") for 4 LED Modules - use with Frame Clips
C	SA1638	Frame Clips

Questions or Missing Parts Call Customer Service (800) 526-0650

M-F 7:30 a.m. - 5:30 p.m. (Eastern Time) www.tetra-fish.com

© 2015 Yorktown Technologies, L.P.

IMPORTANT SAFEGUARDS

WARNING: To guard against injury, basic safety precautions should be observed, including the following:

READ AND FOLLOW ALL SAFETY INSTRUCTIONS

DANGER: To avoid possible electric shock, special care should be taken since water is employed in the use of aquarium equipment. For each of the following situations, do not attempt repairs by yourself; return the appliance to an authorized service facility for service or discard the appliance:

1. A. If an appliance falls into the water, DON'T reach for it! First unplug it and then retrieve it. If electrical components of the appliance get wet, unplug the appliance immediately. If the filter shows any sign of abnormal water leakage, immediately unplug it from the power source.

B. Carefully examine the appliance after installation. It should not be plugged in if there is water on parts not intended to be wet.

C. Do not operate any appliance if it has a damaged cord or plug, or if it is malfunctioning or has been dropped or damaged in any manner.

D. To avoid the possibility of the appliance plug or receptacle getting wet, position aquarium stand and tank to one side of a wall-mounted receptacle to prevent water from dripping onto the receptacle or plug. A drip loop, shown in the figure below, should be arranged by the user for each cord connecting an aquarium appliance to a receptacle. The drip loop is that part of the cord below the level of the receptacle, or the connector if an extension cord is used, to prevent water traveling along the cord and coming in contact with the receptacle.

E. If the transformer or receptacle does get wet, DON'T unplug the cord. Disconnect the fuse or circuit breaker that supplies power to the appliance. Then, unplug and examine for presence of water in the receptacle.

2. Close supervision is necessary when any appliance is used by or near children.

3. To avoid injury, do not contact moving parts or hot parts such as heaters, reflectors, lamp bulbs, and the like.

4. Always unplug an appliance from an outlet when not in use, before putting on or taking off parts, and before cleaning. Never yank cord to pull plug from outlet. Grasp the plug and pull to disconnect.

5. Do not use an appliance for other than intended use. The use of attachments not recommended or sold by the appliance manufacturer may cause an unsafe condition.

6. Do not install or store the appliance where it will be exposed to the weather or to temperatures below freezing.

7. Make sure an appliance mounted on a tank is securely installed before operating it.

8. Read and observe all the important notices on the appliance.

9. If an extension cord is necessary, a cord with a proper rating should be used. A cord rated for less amperes or watts than the appliance rating may overheat. Care should be taken to arrange the cord so that it will not be tripped over or pulled.

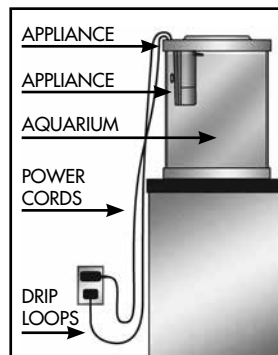

2

Install LED Lights

A. Position Hood face up with the Feeding Hole closest to you.

B. Place each LED Light Module into each track **at an angle** and rotate to snap into place.

NOTE: The LED Light Module closest to the power adapter should be placed near the Cord Track.

C. Route the cord to the back of the hood using the Cord Track on the right side of the hood.

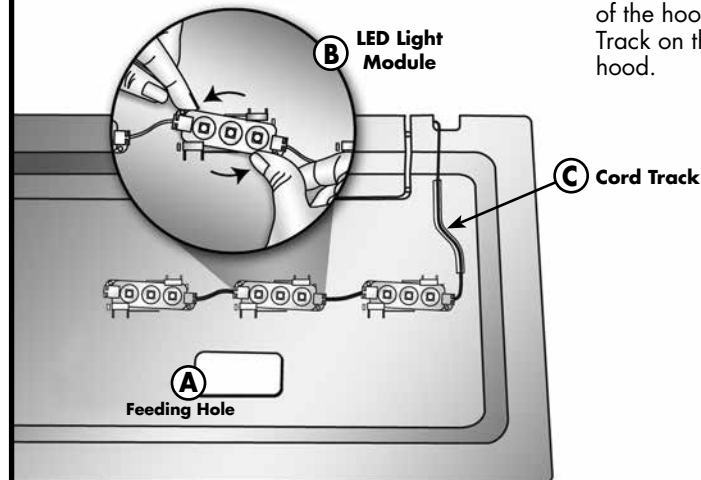

3

Attach Frame Clips

For Hood models without Frame Clips move on to step 4.

A. Place Hood on aquarium frame. Place Frame Clips onto aquarium back frame, aligning them with the Hood Hinges. **DO NOT** snap Frame Clips onto aquarium back frame yet.

B. Remove Hood, keeping Frame Clips in position. Lift Frame Clips and rotate them toward the interior of the aquarium. Fit each lip of the Frame Clips over the recessed edge of the aquarium back frame.

C. Rotate Frame Clips towards the back of aquarium and snap firmly into place.

D. Attach Hood by aligning Hood Hinges into slots on Frame Clips. Press down directly on Hood Hinges to snap Hood into place.

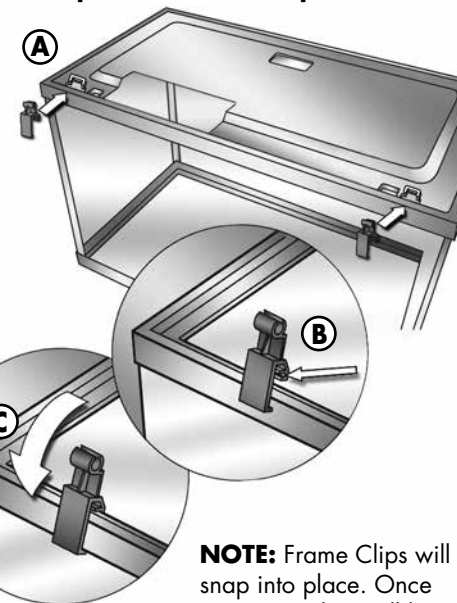

NOTE: Frame Clips will snap into place. Once in position they will be difficult to adjust.

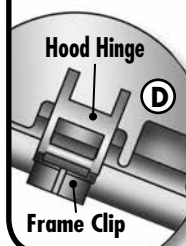

SAVE THESE INSTRUCTIONS