

## 4 Hood & Filter Placement and Start Up

**A.** For kits 20g, 29g, and 55g remove the perforated cut-out to accommodate a power filter. Remove both cut-outs to accommodate larger power filters.

**B.** Attach AC Adapter Plug into the Jack on the end of the LED Light Strand.

**C.** Plug AC adapter into power outlet. Make a Drip Loop for safety.

**D.** Use Light Switch to power LEDs On & OFF.

**Remove Cutout and Install Filter**

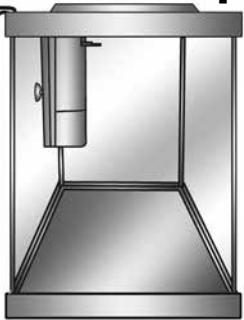
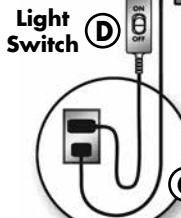
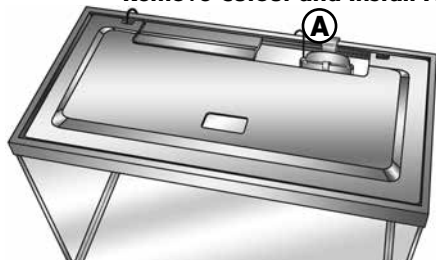

**IMPORTANT:**  
Always unplug the LED Lights before inspecting or beginning any maintenance procedures.

**Drip Loop (for safety)**

### Troubleshooting Guidelines

**NOTE:** The first time the LED light is turned on, it may take several seconds to light. If the light does not come on after one minute, please contact customer service at 1-800-526-0650. This delay should only occur the first time the light is used.

**If the LED hood does not fit snug in the aquarium frame:** If your hood comes with frame clips, make sure they are installed on the aquarium frame properly.

**If the LED lights won't turn on:** Make sure that the AC Adapter is plugged into an electrical source, and the Quick Disconnect is completely connected. Check to make sure the On/Off Switch is set to the 'On' position.

**If the LED lights fall into the water:** Unplug the low voltage AC Adapter plug/power cord. Allow the LED lights to dry out fully before turning 'On' again.

**If the LED Light Modules won't slide into place:** Make sure the Modules are positioned properly in the track. Realign the strand of LED's with the tracks in which they belong before sliding into place, then follow the Quick Setup Guide instructions. The Modules may sit within the track at a slight angle, which is normal.

**LIMITED WARRANTY:** Spectrum Brands, Inc. warrants this Tetra® LED Hood against defects in material or workmanship for one year from the date of original purchase, subject to the conditions and exceptions stated below. Your sales receipt is your Proof-of-Date-of-Purchase. If the product exhibits such a defect, Spectrum Brands, Inc. will repair or replace it, at Spectrum Brands' option, without cost for parts or labor. The product must be shipped postage paid to Spectrum Brands, Inc. Proof-of-Date-of-Purchase is required. You are responsible for proper shipping. Call Customer Service at **1-800-526-0650** for return authorization and shipping address.

This warranty does not cover damage caused by accident, misuse, abuse or failure to follow the instructions accompanying this product. All implied warranties, including any implied warranty of merchantability or fitness for any purpose are limited to one year. Fish and plant loss, personal injury, property loss or damage (direct, incidental, or consequential) resulting from the use of this Tetra® LED Hood are not covered by this warranty.

Because some states/provinces do not allow the exclusion or limitation of incidental or consequential damages, or allow limitations on how long an implied warranty lasts, the above limitations or exclusion may not apply to you. This warranty gives you specific legal rights. You may also have other rights which vary from state/province to state/province.

### Questions or Missing Parts Call Customer Service (800) 526-0650

M-F 7:30 a.m. - 5:30 p.m. (Eastern Time) [www.tetra-fish.com](http://www.tetra-fish.com)

United Pet Group, a Division of Spectrum Brands, Inc. • 3001 Commerce St., Blacksburg, VA 24060 • 1-800-526-0650

TETRA and MARINELAND are Registered Trademarks of Spectrum Brands, Inc. AQUEON is a Registered Trademark of Central Garden & Pet Company.

Copyright © 2015 Spectrum Brands, Inc.

## Start Here - Tetra® LED Aquarium Hoods

Quick Setup Guide for Kit Sizes: 5, 10, 20, 29, & 55 gallons

1

### Parts Check

**NOTE:** Kit 5g doesn't come with Frame Clips. Kit 55 comes with 2 hoods, but only one Light Strand and AC Adapter Plug to power both hoods. Kit 20g, 29g, and 55g include separate Light Strands and AC Adapters, as pictured. Kit 5g and 10g include Light Strands with adapters attached.

Number of Light Modules varies by hood size. Some hoods include two sets of frame clips, one set for Marineland® and Tetra® aquariums, and one for Aqueon® aquariums. When installing the frame clips, select the clip set that fits best on your aquarium frame.

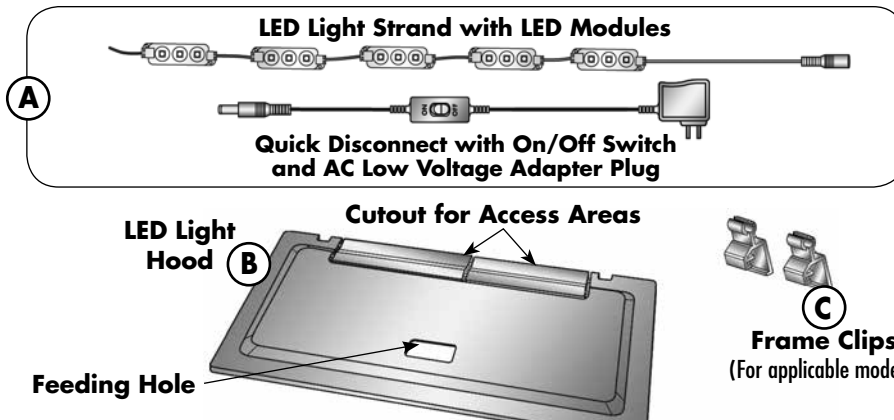

**LED Light Strand with LED Modules**

A

**Quick Disconnect with On/Off Switch and AC Low Voltage Adapter Plug**

**LED Light Hood**

**Cutout for Access Areas**

B



C

**Frame Clips (For applicable models)**

**Feeding Hole**

### Replacement Parts List

KEY	ITEM #	DESCRIPTION	Quantity Per Kit Size				
			5g	10g	20g	29g	55g
A	R05040	1 LED Light Strand & AC Adapter	1				
A	R05042	3 LED Light Strands & AC Adapter		1			
A	R04075	5 LED Light Strand			1		
A	R04076	7 LED Light Strand				1	
A	R09079	10 LED Light Strand					1
A	R04077-02	AC Adapter (20g, 29g & 55g Only)			1	1	1
B	R03942	LED Light Hood (16" x 8")	1				
B	R04016	LED Light Hood (20" x 10")		1			
B	R04019	LED Light Hood (24" x 12")			1		2
B	R04020	LED Light Hood (30" x 12")				1	
C	SA1638	Frame Clips - 10g Marineland®/Tetra® Aquariums		2			
C	SA1641	Frame Clips - 10g Aqueon® Aquariums		2*			
C	SA1639	Frame Clips - 20/29/37g Marineland®/Tetra® Aqms.			2	2	
C	SA1642	Frame Clips - 20/29/37g Aqueon® Aquariums			2*	2*	
C	SA1640	Frame Clips - 55g Marineland®/Tetra® Aquariums			2*		4
C	SA1643	Frame Clips - 55g Aqueon® Aquariums			2*		4*

\* Included in hoods only, not included in complete aquarium kits

07/15 P/N R09088

# IMPORTANT SAFEGUARDS

**WARNING:** To guard against injury, basic safety precautions should be observed, including the following.

# READ AND FOLLOW ALL SAFETY INSTRUCTIONS

**DANGER:** Since water is employed in the use of aquarium equipment, special care should be taken to avoid electric shock. For each of the following situations, do not attempt to repair the appliance yourself. Return it to an authorized service facility for service, or discard it.

- A.** If the appliance falls into the water, do not reach for it. First unplug it and then retrieve it.

**B.** If electrical components of the appliance get wet, unplug the appliance immediately.

**C.** Carefully examine the appliance after installation. It should not be plugged in if there is water on parts not intended to get wet.

**D.** Do not operate any appliance if it has a damaged cord or plug, if it is malfunctioning, or if it has been dropped or damaged in any manner.

**E.** To avoid the possibility of water dripping onto the appliance plug or outlet, position aquarium stand and tank to one side of a wall-mounted outlet. A "drip loop" (see illustration) should be arranged for each cord connecting an aquarium appliance to an outlet. The "drip loop" is the part of the cord below the level of the outlet (or extension cord connector) that prevents water from traveling along the cord to the outlet. If the plug or outlet gets wet, do not unplug the cord. Disconnect the fuse or circuit breaker that supplies power to the appliance. Then unplug the appliance and examine the outlet for presence of water.
- Close supervision is necessary when any appliance is used by or near children.
- Always unplug an appliance from an outlet when it is not in use, before putting on or taking off its parts, and before cleaning it. Never yank cord to pull plug from outlet. Grasp the plug and pull to disconnect.
- If an extension cord is necessary, a cord with a proper rating should be used. A cord rated for fewer amperes or watts than the appliance rating may overheat. Care should be taken to arrange the cord so that it will not be tripped over or pulled.
- Do not use an appliance for other than its intended use. The use of attachments not recommended or sold by the appliance manufacturer may cause an unsafe condition.
- Do not install or store the appliance where it will be exposed to the weather or to temperatures below freezing.
- Make sure the appliance is securely mounted on aquarium before operating it.

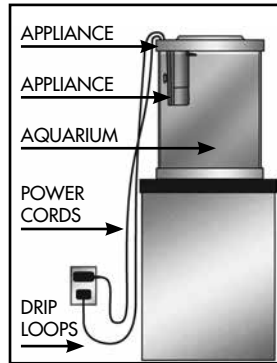

## 2

## Install LED Light/s

- Position Hood face up with the Fish Feeding Hole closest to you.
- Slide each LED Light Module into each track **at an angle**. Once installed in the Tracks, LED Modules may sit **slightly askew**, this is normal.

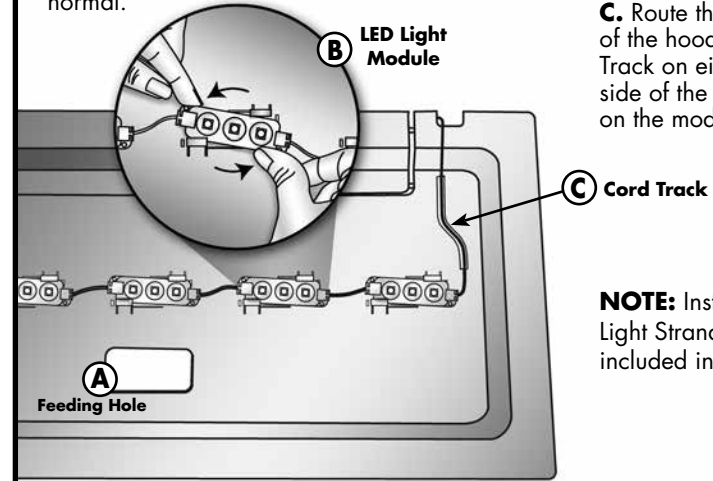

- NOTE:** The LED Light Module closest to the power adapter should be placed near the Cord Track you plan to use to route the cord to the back of the tank.
- C.** Route the cord to the back of the hood using the Cord Track on either the right or left side of the hood, depending on the model.

**NOTE:** Install the 10 LED Light Strand across both hoods included in the 55 gallon kit.

## 3

## Attach Frame Clips

For Hood models without Frame Clips move on to step 4.

- Place Hood on aquarium frame. Place Frame Clips onto aquarium back frame, aligning them with Hood Hinges. **DO NOT** snap Frame Clips onto aquarium back frame yet.
- Remove Hood, keeping Frame Clips in position. Lift Frame Clips and rotate toward interior of the aquarium. Fit each lip of Frame Clips over recessed edge of aquarium back frame.
- Rotate Frame Clips towards back of aquarium and snap firmly into place.
- To attach Hood to Frame Clips, place Hood flat on aquarium in closed position. Align Hood Hinges into slots on Frame Clips. Push down evenly on top surface of Hood Hinge until it snaps into Frame Clip. Repeat for all hinges.

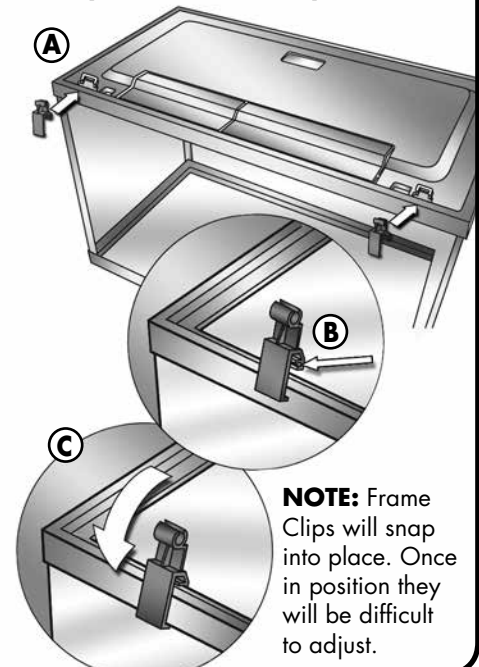

**NOTE:** Frame Clips will snap into place. Once in position they will be difficult to adjust.

# SAVE THESE INSTRUCTIONS